

Console Type Series
Floor

Air Conditioner installation manual

Planet
First

100%
Recycled Paper

This manual is made with 100% recycled paper.



imagine the possibilities

Thank you for purchasing this Samsung product.
To receive more complete service, please
register your product at
www.samsung.com/register

ENDB68-03630A-1

SAMSUNG



Большая библиотека технической документации
<http://splitoff.ru/tehn-doc.html>
каталоги, инструкции, сервисные мануалы, схемы.

Contents

INSTALLATION PARTS

Safety precautions	3
Preparation for Installation	5
Accessories.....	5
Selecting the installation location.....	6
Indoor unit installation	8
Purging the unit	9
Connecting the refrigerant pipe	10
Cutting/flaring the pipes.....	11
Performing leak test & insulation	12
Drain hose installation.....	13
Wiring work	14
Setting an indoor unit address and installation option.....	17
Final check and trial operation	26
Providing information for user	26
Troubleshooting.....	26

Safety precautions

(Carefully follow the precautions listed below because they are essential to guarantee the safety of the equipment.)



WARNING

- Always disconnect the air conditioner from the power supply before servicing it or accessing its internal components.
- Verify that installation and testing operations are performed by qualified personnel.
- Verify that the air conditioner is not installed in an easily accessible area.

GENERAL INFORMATION

- ◆ Carefully read the content of this manual before installing the air conditioner and store the manual in a safe place in order to be able to use it as reference after installation.
- ◆ For maximum safety, installers should always carefully read the following warnings.
- ◆ Store the operation and installation manual in a safe location and remember to hand it over to the new owner if the air conditioner is sold or transferred.
- ◆ This manual explains how to install an indoor unit with a split system with two SAMSUNG units. The use of other types of units with different control systems may damage the units and invalidate the warranty. The manufacturer shall not be responsible for damages arising from the use of non compliant units.
- ◆ This product has been determined to be in compliance with the Low Voltage Directive (2006/95/EC), and the Electromagnetic Compatibility Directive (2004/108/EC) of the European Union.
- ◆ The manufacturer shall not be responsible for damage originating from unauthorized changes or the improper connection of electric and hydraulic lines. Failure to comply with these instructions or to comply with the requirements set forth in the "Operating limits" table, included in the manual, shall immediately invalidate the warranty.
- ◆ The air conditioner should be used only for the applications for which it has been designed: the indoor unit is not suitable to be installed in areas used for laundry.
- ◆ Do not use the units if damaged. If problems occur, switch the unit off and disconnect it from the power supply.
- ◆ In order to prevent electric shocks, fires or injuries, always stop the unit, disable the protection switch and contact SAMSUNG's technical support if the unit produces smoke, if the power cable is hot or damaged or if the unit is very noisy.
- ◆ Always remember to inspect the unit, electric connections, refrigerant tubes and protections regularly. These operations should be performed by qualified personnel only.
- ◆ The unit contains moving parts, which should always be kept out of the reach of children.
- ◆ Do not attempt to repair, move, alter or reinstall the unit. If performed by unauthorized personnel, these operations may cause electric shocks or fires.
- ◆ Do not place containers with liquids or other objects on the unit.
- ◆ All the materials used for the manufacture and packaging of the air conditioner are recyclable.
- ◆ The packing material and exhaust batteries of the remote control (optional) must be disposed of in accordance with current laws.
- ◆ The air conditioner contains a refrigerant that has to be disposed of as special waste. At the end of its life cycle, the air conditioner must be disposed of in authorized centers or returned to the retailer so that it can be disposed of correctly and safely.

INSTALLING THE UNIT

IMPORTANT: When installing the unit, always remember to connect first the refrigerant tubes, then the electrical lines. Always disassemble the electric lines before the refrigerant tubes.

- ◆ Upon receipt, inspect the product to verify that it has not been damaged during transport. If the product appears damaged, DO NOT INSTALL it and immediately report the damage to the carrier or retailer (if the installer or the authorized technician has collected the material from the retailer.)
- ◆ After completing the installation, always carry out a functional test and provide the instructions on how to operate the air conditioner to the user.
- ◆ Do not use the air conditioner in environments with hazardous substances or close to equipment that release free flames to avoid the occurrence of fires, explosions or injuries.
- ◆ The air conditioner should be used only for the applications for which it has been designed: the indoor unit is not

Safety precautions

- ◆ Our units must be installed in compliance with the spaces indicated in the installation manual to ensure either accessibility from both sides or ability to perform routine maintenance and repairs. The units' components must be accessible and that can be disassembled in conditions of complete safety either for people or things. For this reason, where it is not observed as indicated into the Installation Manual, the cost necessary to reach and repair the unit (in safety, as required by current regulations in force) with slings, trucks, scaffolding or any other means of elevation won't be considered in-warranty and charged to end user.

POWER SUPPLY LINE, FUSE OR CIRCUIT BREAKER

- ◆ Always make sure that the power supply is compliant with current safety standards. Always install the air conditioner in compliance with current local safety standards.
- ◆ Always verify that a suitable grounding connection is available.
- ◆ Verify that the voltage and frequency of the power supply comply with the specifications and that the installed power is sufficient to ensure the operation of any other domestic appliance connected to the same electric lines.
- ◆ Always verify that the cut-off and protection switches are suitably dimensioned.
- ◆ Verify that the air conditioner is connected to the power supply in accordance with the instructions provided in the wiring diagram included in the manual.
- ◆ Always verify that electric connections (cable entry, section of leads, protections...) are compliant with the electric specifications and with the instructions provided in the wiring scheme. Always verify that all connections comply with the standards applicable to the installation of air conditioners.



CAUTION

- ◆ **Make sure that you earth the cables.**
 - **Do not connect the earth wire to the gas pipe, water pipe, lighting rod or telephone wire.**
If earthing is not complete, electric shock or fire may occur.
- ◆ **Install the circuit breaker.**
 - **If the circuit breaker is not installed, electric shock or fire may occur.**
- ◆ **Make sure that the condensed water dripping from the drain hose runs out properly and safely.**
- ◆ **Install the power cable and communication cable of the indoor and outdoor unit at least 1m away from the electric appliance.**
- ◆ **Install the indoor unit away from lighting apparatus using the ballast.**
 - **If you use the wireless remote control, reception error may occur due to the ballast of the lighting apparatus.**
- ◆ **Do not install the air conditioner in following places.**
 - **Place where there is mineral oil or arsenic acid.**
Resin parts flame and the accessories may drop or water may leak.
The capacity of the heat exchanger may reduce or the air conditioner may be out of order.
 - **The place where corrosive gas such as sulfurous acid gas generates from the vent pipe or air outlet.**
The copper pipe or connection pipe may corrode and refrigerant may leak.
 - **The place where there is a machine that generates electromagnetic waves.**
The air conditioner may not operate normally due to control system.
 - **The place where there is a danger of existing combustible gas, carbon fiber or flammable dust.**
The place where thinner or gasoline is handled.
Gas may leak and it may cause fire.

Preparation for Installation

When deciding on the location of the air conditioner with the owner, the following restrictions must be taken into account.

General

Do NOT install the air conditioner in a location where it will come into contact with the following elements:

- ◆ Combustible gases
- ◆ Saline air
- ◆ Machine oil
- ◆ Sulphide gas
- ◆ Special environmental conditions









If you must install the unit in such conditions, first consult your dealer.

Avoid installing the air conditioner:

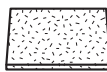
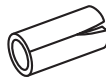
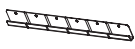
- ◆ In areas where it is exposed to direct sunlight. Close to heat sources.
- ◆ In damp areas or locations where it could come into contact with water (for example rooms used for laundry)
- ◆ In areas where curtains and furniture could affect the supply and discharge of air.
- ◆ Without leaving the required minimum space around the unit (as shown in the drawing).
- ◆ In scarcely ventilated areas.
- ◆ On surfaces that are unable to support the weight of the unit without deforming, breaking or causing vibrations during the use of the air conditioner.
- ◆ In a position that does not enable the condensate drainage pipe to be correctly installed (at the end of the installation. It is always essential to check the efficiency of the drainage system.)
- ◆ Only for floor standing type installation.

Accessories

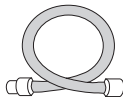
**The following accessories are supplied with the indoor unit.
The type and quantity may differ depending on the specifications.**

User's manual 	Installation manual 	Insulation Install Outlet 	Insulation Install 	Bracket Hanger 	Anti-allergy filter 
Cable-tie 	Wireless remote control 	Battery 	Drain Hose 	M4x12 tapped 	Deodorizing filter 

Selecting the installation location

Indoor Unit

- ◆ This unit has to be installed as floor type only.
- ◆ There must be no obstacles near the air inlet and outlet.
- ◆ Select a convenient location that permits the air to reach every corner of the area to be cooled.
- ◆ Pre-plan for easy and short routing of the refrigerant tubing and wiring to the outdoor unit.
- ◆ There should be no flammable gas, alkaline, substances present in the air.
- ◆ Maintain sufficient clearance around the indoor unit.
- ◆ Make sure that the water dripping from the drain hose runs away correctly and safely.
- ◆ Do not install the unit where it will be exposed to direct sunlight.

Space requirements for installation & service

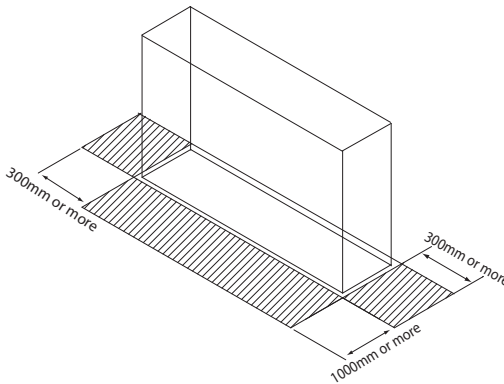

CAUTION

The units must be installed according to distances declared, in order to permit accessibility from each side, either to guarantee correct operation of maintenance or repairing products.

The unit's parts must be reachable and removable completely under safety condition (for people or things).

This model can be installed with no side space. But it is recommended installing like above.

AM***FNJD***

Unit : mm

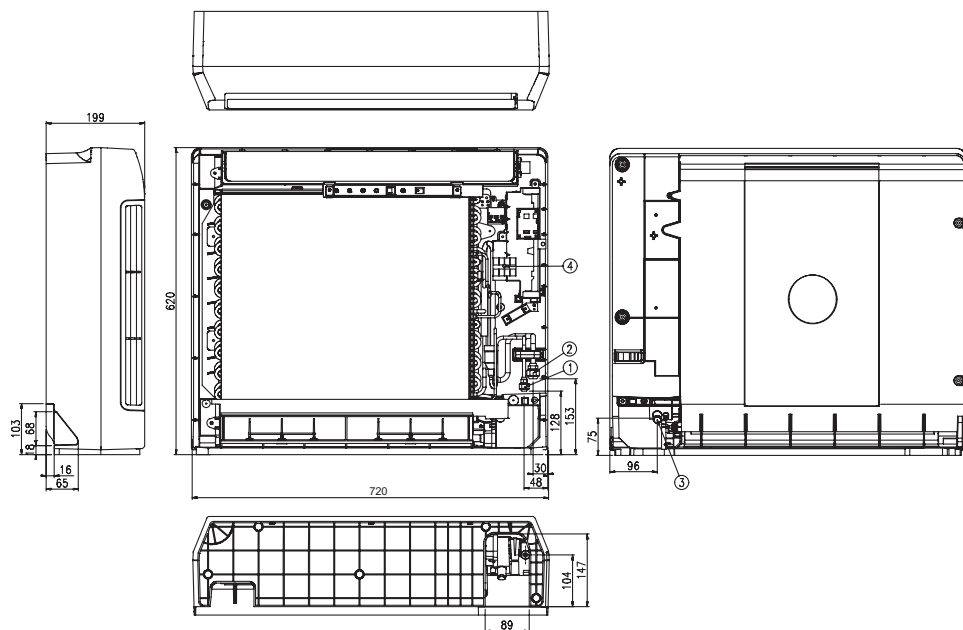

No.	Name	Description
1	Liquid pipe connection	ø6.35
2	Gas pipe connection	ø12.7
3	Drain pipe connection	ID: ø12 ; OD: ø18
4	Power supply connection	-

* Maximum installation height: up to 3.6m

* Condensate discharge pump(built-in): Max. 750mm

* Length of pipes and difference in height: see the outdoor unit installation manual

* Vacuum and refrigerant charge: see the outdoor unit installation manual

Indoor unit installation

It is recommended to install the refnet joint before installing the indoor unit.

- 1 When you install the indoor with side-pipe connection, please make space more than 300mm from the wall at the pipe connection direction.

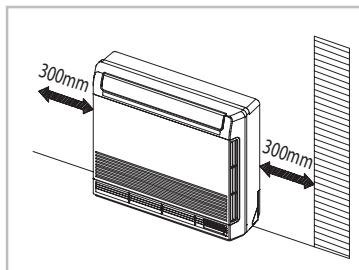

- 2 When you install the indoor at the inclined floor, please lean the set toward the drain hose and pipe connection to prevent water overflowing.

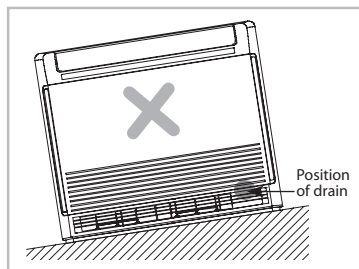
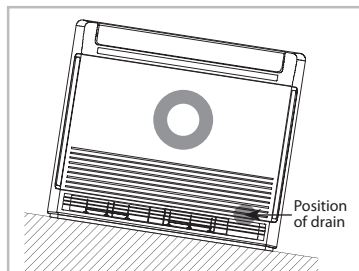

- 3 Please remove the items when set is installed.
*AM028/036FNJD*** : 6 Items
*AM056FNJD*** : 7 Items

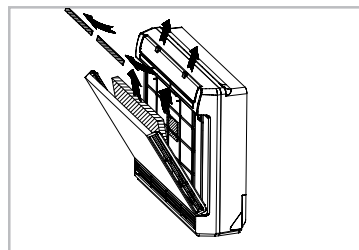

- 4 The body front should be opened to connect pipes. Please release the 4 screws of body front and then pull it out from the bottom of the set.

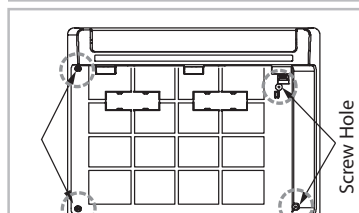

5 Making a hole on the wall.

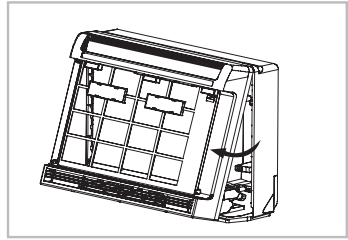

6 The pipes & cable should be go through the bottom back hole.

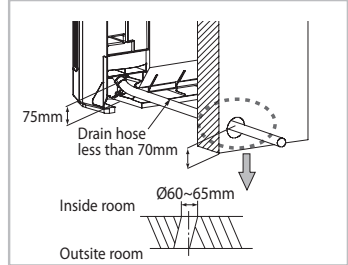

7 Hanging the indoor unit on the Bracket Hanger, then fix the Indoor Unit by using 4 Screws.

◆ Case 1. Installing on the floor : Must fix 4 screws on the wall, make the indoor not to fall down(For safety installation)

◆ Case 2. Hanging on the wall : Follow the installation guide supplied in the accessory part.

※ Screw positions are specified on the installation guide.

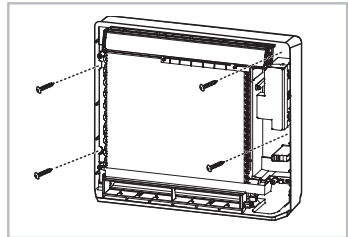
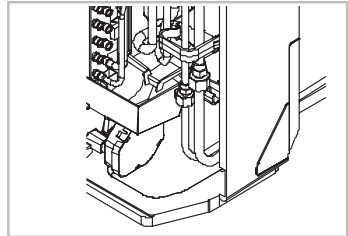

Purging the unit

From factory the unit is supplied and set with a pre-charge of nitrogen gas (insert gas). Therefore, all insert gas must be purged before connecting the assembly piping.

Unscrew the pinch pipe at the end of each refrigerant pipe.

Result: All inert gas escapes from the indoor unit.

Note To prevent dirt or foreign objects from getting into the pipes during installation, do NOT remove the pinch pipe completely until you are ready to connect the piping.

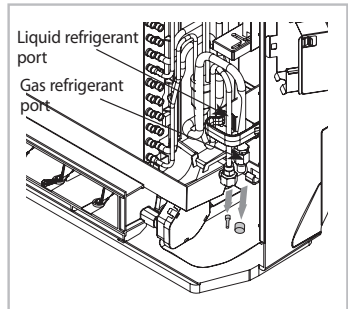

※ The designs and shape are subject to

Connecting the refrigerant pipe

There are two refrigerant pipes of differing diameters:

- ◆ A smaller one for the liquid refrigerant
- ◆ A larger one for the gas refrigerant
- ◆ The inside of copper pipe must be clean & has no dust.

- 1 Remove the pinch pipe on the pipes and connect the assembly pipes to each pipe, tightening the nuts, first manually and then with a torque wrench, a spanner applying the following torque.

Outer Diameter	Torque	
	kgf·cm	N·m
6.35 mm	140~180	14~18
9.52 mm	350~430	34~42
12.70 mm	500~620	49~61
15.88 mm	690~830	68~82

Note Must apply refrigerant oil on the flaring area to prevent a leak.

- 2 Be sure that there must be no crack or kink on the bended area.
- 3 Cut off any excess foam insulation.
- 4 Be sure that there must be no crack or wave on the bended area.
- 5 It would be necessary to double the insulation thickness(10mm or more) to prevent condensation even on the insulator when if the installed area is warm and humid.
- 6 Do not use joints or extensions for the pipes that connect the indoor and outdoor unit. The only permitted connections are those for which the units re designed.



- ◆ Connect the indoor and outdoor units using pipes with flared connections(not supplied). For the lines, use insulated, unwelded, degreased and deoxidized copper pipe,(Cu DHP type to ISO1337), suitable for operating pressures of at least 4200kPa and for a burst pressure of at least 20700kPa. Copper pipe for hydro-sanitary ap- plications is completely unsuitable.
- ◆ For sizing and limits (height difference, line length, max. bends, refrigerant charge, etc.) see the outdoor unit installation manual.
- ◆ All refrigerant connection must be accessible, in order to permit either unit maintenance or removal completely.

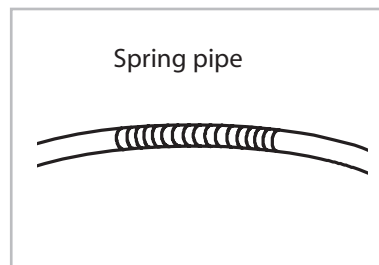
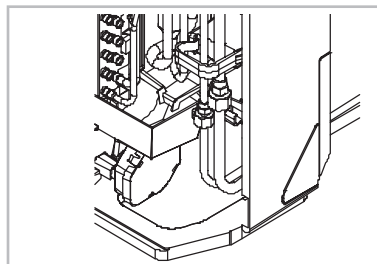
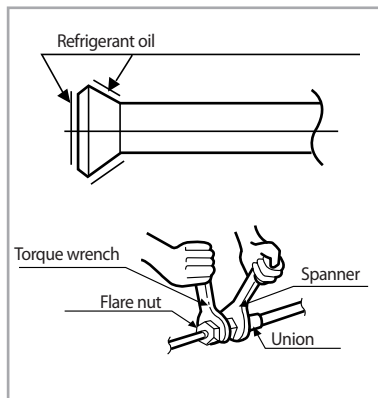

- ◆ Use the bender which have a minimum bending radius when you bend the pipe.
- ◆ Be careful so that the pipes is bended one time only. Piping will be very difficult if you repeat the bending more than twice.
- ◆ If you bend the pipe by using spring Bending radius should be more than 100mm so that pipe is not distorted.

Cutting/flaring the pipes

1 Make sure that you prepared the required tools.
(pipe cutter, reamer, flaring tool and pipe holder)

2 If you want to shorten the pipe, cut it using a pipe cutter ensuring that the cut edge remains at 90° with the side of the pipe. There are some examples of correctly and incorrectly cut edges below.

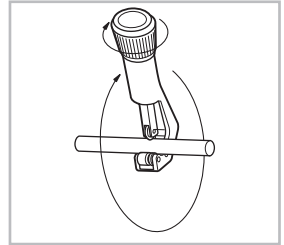
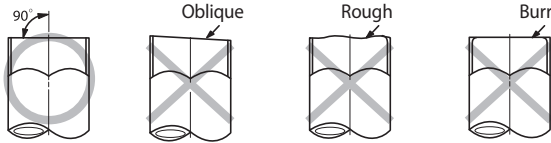

3 To prevent a gas leak, remove all burrs at the cut edge of the pipe using a reamer.

4 Carry out flaring work using flaring tool as shown below.

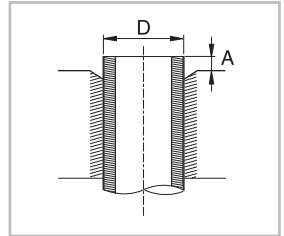
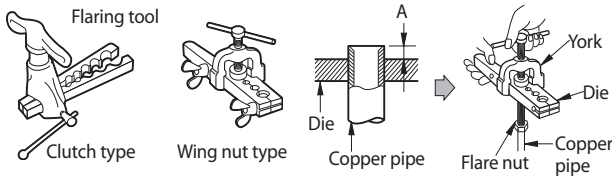

Outer diameter (mm)	A(mm)		
	Flare tool for R410A clutch type	Conventional flare tool	
		Clutch type	Wing nut type
6.35	0~0.5	1.0~1.5	1.5~2.0
9.52	0~0.5	1.0~1.5	1.5~2.0
12.70	0~0.5	1.0~1.5	1.5~2.0
15.88	0~0.5	1.0~1.5	1.5~2.0

5 Check if you flared the pipe correctly. There are some examples of incorrectly flared pipes below.



6 Align the pipes and tighten the flare nuts first manually and then with a torque wrench, applying the following torque.

Outer diameter (mm)	Connection Torque		Flare dimension (mm)	Flare shape (mm)
	kgf-cm	N-m		
6.35	140~180	14~18	8.70~9.10	
9.52	350~430	34~42	12.80~13.20	
12.70	500~620	49~61	16.20~16.60	
15.88	690~830	68~82	19.30~19.70	

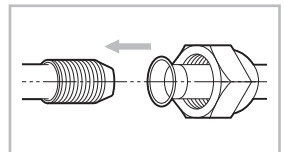

In case of reading brazing, you must work with Nitrogen gas blowing

Performing leak test & insulation

Leak test

LEAK TEST WITH NITROGEN (before opening valves)

In order to detect basic refrigerant leaks, before recreating the vacuum and recirculating the R410A, it's responsible of installer to pressurize the whole system with nitrogen (using a pressure regulator) at a pressure above 4.1MPa (gauge).

LEAK TEST WITH R410A (after opening valves)

Before opening valves, discharge all the nitrogen into the system and create vacuum. After opening valves check leaks using a leak detector for refrigerant R410A.



CAUTION

Discharge all the nitrogen to create a vacuum and charge the system.

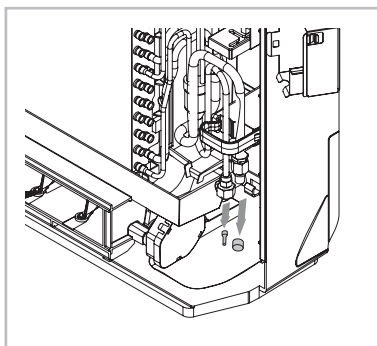

* The designs and shape are subject to change according to the model.

Insulation

Once you have checked that there are no leaks in the system, you can insulate the piping and hose.

- 1 To avoid condensation problems, place **T13.0 or thicker Acrylonitrile Butadien Rubber** separately around each refrigerant pipe.

Note Always make the seam of pipes face upwards.

- 2 Wind insulating tape around the pipes and drain hose avoiding to compress the insulation too much.
- 3 Finish wrapping insulating tape around the rest of the pipes leading to the outdoor unit.
- 4 The pipes and electrical cables connecting the indoor unit with the outdoor unit must be fixed to the wall with suitable ducts.



CAUTION

All refrigerant connection must be accessible, in order to permit either unit maintenance or removing it completely.

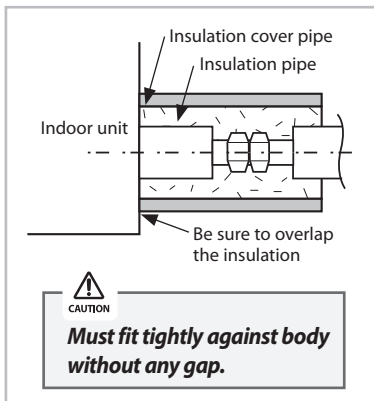
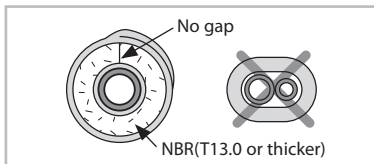

Drain hose installation

**When installing the drain hose for the indoor unit, check if condensation draining is adequate.
When passing the drain hose through the 65-mm hole drilled in the wall, check the following:**

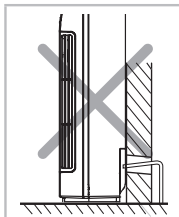

The hose must NOT slant upwards.

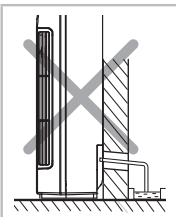

The end of the drain hose must NOT be placed under water.

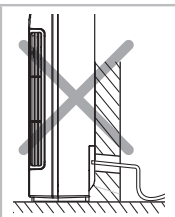

Do NOT bend the hose in different directions.

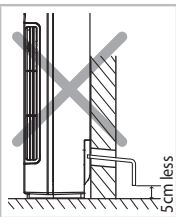

Keep a clearance of at least 5cm between the end of the hose and the ground.

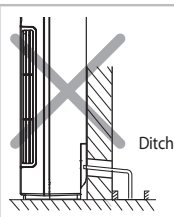

Do NOT place the end of the drain hose in a hollow.

Drain hose installation

- 1 If necessary, connect the 2-meter extension drain hose to the drain hose.
- 2 If you use the extension drain hose, insulate the inside of the extension drain hose with a shield.
- 3 Fit the drain hose into 1 of 2 drain hose holes, then fix the end of the drain hose tightly with a clamp.
 - > If you don't use the other drain hose hole, block it with a rubber stopper.
- 4 Pass the drain hose under the refrigerant pipe, keeping the drain hose tight.
- 5 Pass the drain hose through the hole in the wall. Check if it slants downwards as seen in the picture.

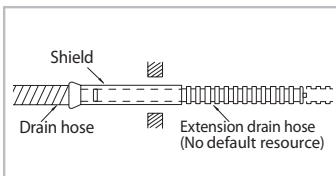

> **The hose will be fixed permanently into position after finishing the installation and the gas leak test; refer to page 12 for further details.**

6-Ways to connect Drain Hose and Pipe

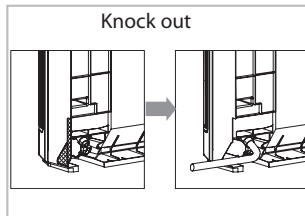
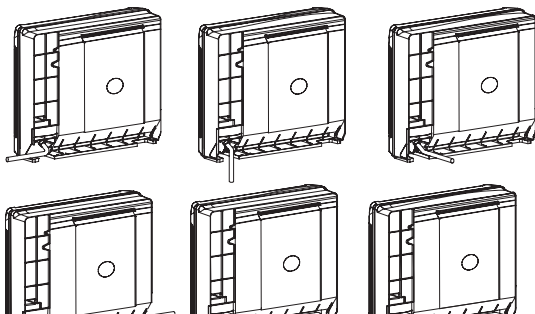

Wiring work

Power and communication cable connection

- 1 Before wiring work, you must turn off all power source.
- 2 Indoor unit power should be supplied through the breaker(ELCB or MCCB+ELB) separated by the outdoor power.
ELCB:Earth Leakage Circuit Breaker
MCCB:Molded Case Circuit Breaker
ELB:Earth Leakage Breaker
- 3 The power cable should be used only copper wires.
- 4 Connect the power cable(1(L), 2(N)) among the units within maximum length and communication cable(F1, F2) each.
- 5 Connect F3, F4(for communication) when installing the wired remote control.

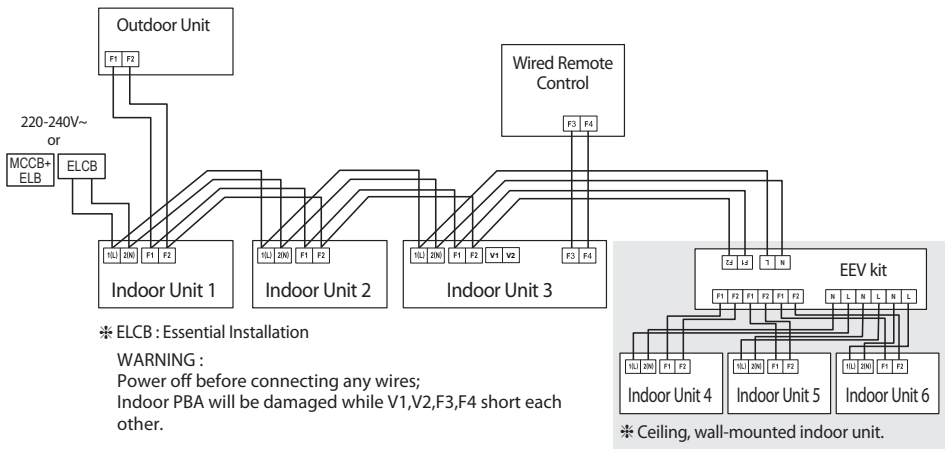

Selecting compressed ring terminal

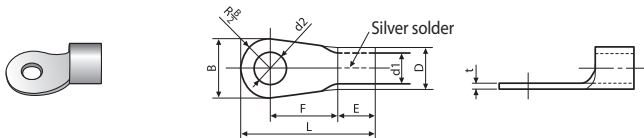

Nominal dimensions for cable (mm ²)	Nominal dimensions for screw (mm)	B		D		d1		E	F	L	d2		t
		Standard dimension (mm)	Allowance (mm)	Standard dimension (mm)	Allowance (mm)	Standard dimension (mm)	Allowance (mm)				Standard dimension (mm)	Allowance (mm)	
1.5	4	6.6	±0.2	3.4	+0.3	1.7	±0.2	4.1	6	16	4.3	+0.2	0.7
	4	8			-0.2							0	
2.5	4	6.6	±0.2	4.2	+0.3	2.3	±0.2	6	6	17.5	4.3	+0.2	0.8
	4	8.5			-0.2							0	
4	4	9.5	±0.2	5.6	+0.3	3.4	±0.2	6	5	20	4.3	+0.2	0.9
					-0.2							0	

Specification of electronic wire

Power supply	MCCB	ELB or ELCB	Power cable	Earth cable	Communication cable
Max : 242V Min : 198V	X A	X A, 30mmA 0.1 s	2.5mm ²	2.5mm ²	0.75~1.5mm ²

- ◆ Decide the capacity of ELCB(or MCCB+ELB) by below formula.
- ◆ Supply cords of parts of appliances for outdoor use shall not be lighter than polychloroprene sheathed flexible cord.
(Code designation IEC:60245 IEC 57 / CENELEC: H05RN-F)

※ Rating current

Unit	Model	Rating current
AM*FNJD*	*028*	0.25A
	036	0.29A
	056	0.49A

The capacity of ELCB(or MCCB+ELB) $X [A] = 1.25 \times 1.1 \times \sum A_i$

- * X: The capacity of ELCB(or MCCB+ELB).
- * $\sum A_i$: Sum of Rating currents of each indoor unit.
- * Refer to each installation manual about the rating current of indoor unit.
- ◆ Decide the power cable specification and maximum length within 10% power drop among indoor units.

$$\sum_{k=1}^n \left(\frac{\text{Coef} \times 35.6 \times L_k \times i_k}{1000 \times A_k} \right) < 10\% \text{ of input voltage [V]}$$

* coef: 1.55
* L_k : Distance among each indoor unit[m], A_k : Power cable specification[mm²]
 i_k : Running current of each unit[A]

Example of Installation

- Total power cable length L = 100(m), Running current of each units 1[A]
- Total 10 indoor units were installed

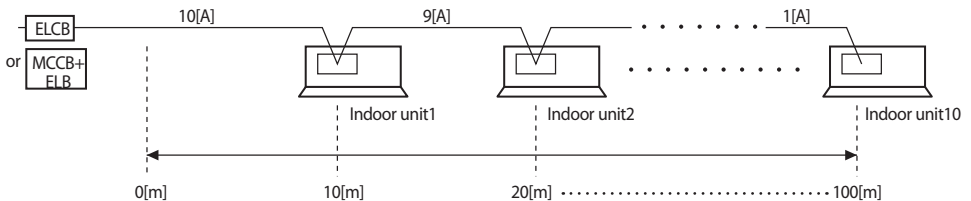

- ◆ Apply following equation.

$$\sum_{k=1}^n \left(\frac{\text{Coef} \times 35.6 \times L_k \times i_k}{1000 \times A_k} \right) < 10\% \text{ of input voltage [V]}$$

※ Calculation

- Installing with 1 sort wire.

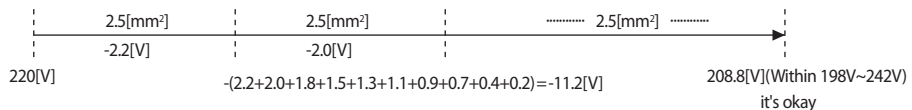

- Installing with 2 different sort wire.

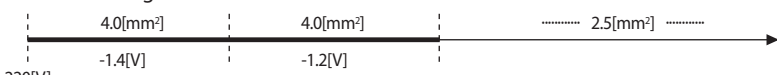

Wiring work(Cont.)



CAUTION

- ◆ **Select the power cable in accordance with relevant local and national regulations.**
- ◆ **Wire size must comply with local and national code.**
- ◆ **For the power cable, use the grade of H07RN-F or H05RN-F materials.**
- ◆ **You should connect the power cable into the power cable terminal and fasten it with a clamp.**
- ◆ **The unbalanced power must be maintained within 10% of supply rating among whole indoor units.**
- ◆ **If the power is unbalanced greatly, it may shorten the life of the condenser. If the unbalanced power is exceeded over 10% of supply rating, the indoor unit is protected, stopped and the error mode indicates.**
- ◆ **To protect the product from water and possible shock, you should keep the power cable and the connection cord of the indoor and outdoor units in the iron pipe.**
- ◆ **Connect the power cable to the auxiliary circuit breaker.**
An all pole disconnection from the power supply must be incorporated in the fixed wiring($\geq 3\text{mm}$).
- ◆ **You must keep the cable in a protection tube.**
- ◆ **Keep distances of 50mm or more between power cable and communication cable.**
- ◆ **Maximum length of power cables are decided within 10% of power drop. If it exceeds, you must consider another power supplying method.**
- ◆ **The circuit breaker(ELCB or MCCB+ELB) should be considered more capacity if many indoor units are connected from one breaker.**
- ◆ **Use round pressure terminal for connections to the power terminal block.**
- ◆ **For wiring, use the designated power cable and connect it firmly, then secure to prevent outside pressure being exerted on the terminal board.**
- ◆ **Use an appropriate screwdriver for tightening the terminal screws. A screwdriver with a small head will strip the head and make proper tightening impossible.**
- ◆ **Over-tightening the terminal screws may break them.**
- ◆ **See the table below for tightening torque for the terminal screws.**

Tightening torque		
	N·m	kgf·cm
M3.5	0.8~1.0	8.0~10.0
M4	1.2~1.5	12.0~14.7

Setting an indoor unit address and installation option

Set the indoor unit address and installation option with remote controller option. Set the each option separately since you cannot set the ADDRESS setting and indoor unit installation setting option at the same time. You need to set twice when setting indoor unit address and installation option.

The procedure of option setting

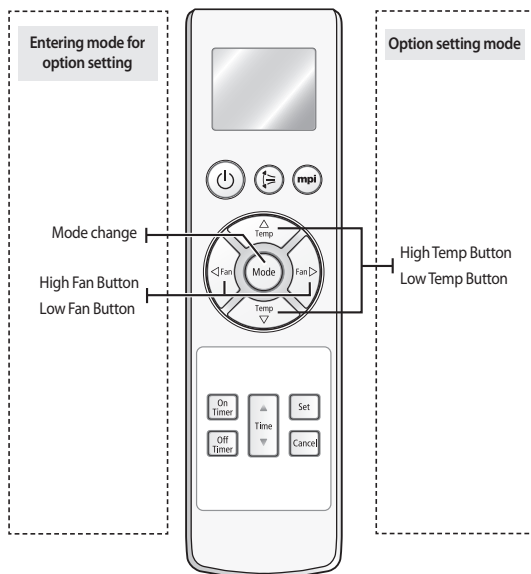

Step 1. Entering mode to set option

1. Remove batteries from the remote controller.
2. Insert batteries and enter the option setting mode while pressing High Temp button and Low Temp button.

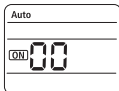
3.  Check if you have entered the option setting status.

Step 2. The procedure of option setting



After entering the option setting status, select the option as listed below.





Option setting is available from SEG1 to SEG 24

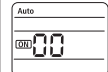





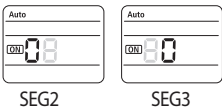
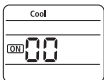
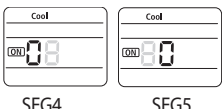
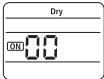
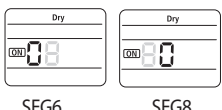
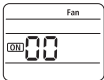
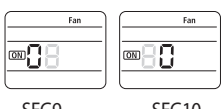

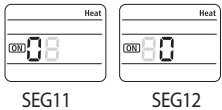
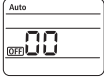
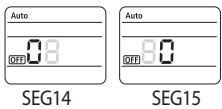

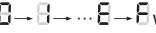
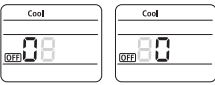

- ◆ SEG1, SEG7, SEG13, SEG19 are not set as page option.
- ◆ Set the SEG2~SEG6, SEG8~SEG12 as ON status and SEG14~18, SEG20~24 as OFF status.

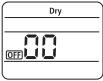
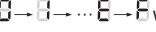
SEG1	SEG2	SEG3	SEG4	SEG5	SEG6	SEG7	SEG8	SEG9	SEG10	SEG11	SEG12
0	X	X	X	X	X	1	X	X	X	X	X
SEG13	SEG14	SEG15	SEG16	SEG17	SEG18	SEG19	SEG20	SEG21	SEG22	SEG23	SEG24
2	X	X	X	X	X	3	X	X	X	X	X

On(SEG1~12)	Off(SEG13~24)
	

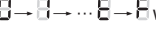
Setting an indoor unit address and installation option (Cont.)

Option setting	Status
<p>1. Setting SEG2, SEG3 option Press Low Fan button(V) to enter SEG2 value. Press High Fan button(^) to enter SEG3 value. Each time you press the button, 0 → 1 → ... 9 → F will be selected in rotation.</p>	
<p>2. Setting Cool mode <input type="checkbox"/> Mode Press Mode button to be changed to Cool mode in the ON status.</p>	
<p>3. Setting SEG4, SEG5 option Press Low Fan button(V) to enter SEG4 value. Press High Fan button(^) to enter SEG5 value. Each time you press the button, 0 → 1 → ... 9 → F will be selected in rotation.</p>	
<p>4. Setting Dry mode <input type="checkbox"/> Mode Press Mode button to be changed to DRY mode in the ON status.</p>	
<p>5. Setting SEG6, SEG8 option Press Low Fan button(V) to enter SEG6 value. Press High Fan button(^) to enter SEG8 value. Each time you press the button, 0 → 1 → ... 9 → F will be selected in rotation.</p>	
<p>6. Setting Fan mode <input type="checkbox"/> Mode Press Mode button to be changed to FAN mode in the ON status.</p>	
<p>7. Setting SEG9, SEG10 option Press Low Fan button(V) to enter SEG9 value. Press High Fan button(^) to enter SEG10 value. Each time you press the button, 0 → 1 → ... 9 → F will be selected in rotation.</p>	
<p>8. Setting Heat mode <input type="checkbox"/> Mode Press Mode button to be changed to HEAT mode in the ON status.</p>	
<p>9. Setting SEG11, SEG12 option Press Low Fan button(V) to enter SEG11 value. Press High Fan button(^) to enter SEG12 value. Each time you press the button, 0 → 1 → ... 9 → F will be selected in rotation.</p>	
<p>10. Setting Auto mode <input type="checkbox"/> Mode Press Mode button to be changed to AUTO mode in the OFF status.</p>	
<p>11. Setting SEG14, SEG15 option Press Low Fan button(V) to enter SEG14 value. Press High Fan button(^) to enter SEG15 value. Each time you press the button, 0 → 1 → ... 9 → F will be selected in rotation.</p>	

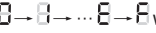
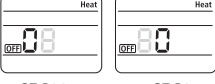
Option setting	Status
<p>12. Setting Cool mode</p> <p> Press Mode button to be change to Cool mode in the OFF status.</p>	
<p>13. Setting SEG16, SEG17 option</p> <p>Press Low Fan button(V) to enter SEG16 value. Press High Fan button(Λ) to enter SEG17 value. Each time you press the button,  will be selected in rotation.</p>	 <p style="text-align: center;">SEG16 SEG17</p>
<p>14. Setting Dry mode</p> <p> Press Mode button to be change to Dry mode in the OFF status.</p>	
<p>15. Setting SEG18, SEG20 option</p> <p>Press Low Fan button(V) to enter SEG18 value. Press High Fan button(Λ) to enter SEG20 value. Each time you press the button,  will be selected in rotation.</p>	 <p style="text-align: center;">SEG18 SEG20</p>
<p>16. Setting Fan mode</p> <p> Press Mode button to be change to Fan mode in the OFF status.</p>	
<p>17. Setting SEG21, SEG22 option</p> <p>Press Low Fan button(V) to enter SEG21 value. Press High Fan button(Λ) to enter SEG22 value. Each time you press the button,  will be selected in rotation.</p>	 <p style="text-align: center;">SEG21 SEG22</p>
<p>18. Setting Heat mode</p> <p> Press Mode button to be change to HEAT mode in the OFF status.</p>	
<p>19. Setting SEG23, SEG24 mode</p> <p>Press Low Fan button(V) to enter SEG23 value. Press High Fan button(Λ) to enter SEG24 value. Each time you press the button,  will be selected in rotation.</p>	 <p style="text-align: center;">SEG23 SEG24</p>

Step 3. Check the option you have set

After setting option, press  button to check whether the option code you input is correct or not.

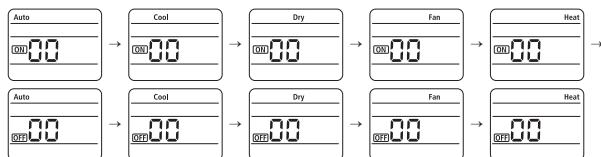

Step 4. Input option

Press operation button  with the direction of remote control for set.
For the correct option setting, you must input the option twice.

Step 5. Check operation

1. Reset the indoor unit by pressing the RESET button of indoor unit or outdoor unit.

Setting an indoor unit address and installation option (Cont.)

Setting an indoor unit address (MAIN/RMC)

- Check whether power is supplied or not.
 - When the indoor unit is not plugged in, there should be additional power supply in the indoor unit.
- The panel(display) should be connected to an indoor unit to receive option.
- Before installing the indoor unit, assign an address to the indoor unit according to the air conditioning system plan.
- Assign an indoor unit address by wireless remote controller.
 - The initial setting status of indoor unit ADDRESS(MAIN/RMC) is "0A0000-100000-200000-300000".

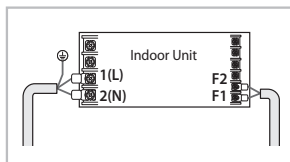

Option No. : 0AXXXX-1XXXXX-2XXXXX-3XXXXX

Option	SEG1		SEG2		SEG3		SEG4		SEG5		SEG6	
Explanation	PAGE		Mode		Setting Main address		100-digit of indoor unit address		10-digit of indoor unit		The unit digit of an indoor unit	
Remote Controller Display												
Indication and Details	Indication	Details	Indication	Details	Indication	Details	Indication	Details	Indication	Details	Indication	Details
	0		A		0	No Main address						
					1	Main address setting mode	0~9	100-digit	0~9	10-digit	0~9	A unit digit
Option	SEG7		SEG8		SEG9		SEG10		SEG11		SEG12	
Explanation	PAGE				Setting RMC address				Group channel(*16)		Group address	
Remote Controller Display												
Indication and Details	Indication	Details	—		Indication	Details	—		Indication	Details	Indication	Details
	1				0	No RMC address						
					1	RMC address setting mode			RMC1	0~2	RMC2	0~F



- ◆ When "A"~"F" is entered to SEG5~6, the indoor unit MAIN ADDRESS is not changed.
- ◆ If you set the SEG 3 as 0, the indoor unit will maintain the previous MAIN ADDRESS even if you input the option value of SEG5~6.
- ◆ If you set the SEG 9 as 0, the indoor unit will maintain previous RMC ADDRESS even if you input the option value of SEG11~12.
- ◆ You cannot set SEG11 and SEG12 as F value at the same time.

Setting an indoor unit installation option (suitable for the condition of each installation location)

- Check whether power is supplied or not.
 - When the indoor unit is not plugged in, there should be additional power supply in the indoor unit.
- The panel(display) should be connected to an indoor unit to receive option.
- Set the installation option according to the installation condition of an air conditioner.
 - The default setting of an indoor unit installation option is "020010-100000- 200000-300000".
 - Individual control of a remote controller(SEG20) is the function that controls an indoor unit individually when there is more than one indoor unit.
- Set the indoor unit option by wireless remote controller.

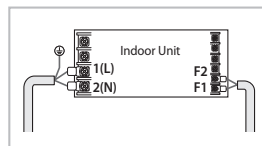

02 series installation option















SEG1	SEG2	SEG3	SEG4	SEG5	SEG6
0	2	--	External room temperature sensor	Central control	FAN RPM compensation
SEG7	SEG8	SEG9	SEG10	SEG11	SEG12
1	Drain pump	Hot water heater	--	EEV Step when heating stops	Master / Slave
SEG13	SEG14	SEG15	SEG16	SEG17	SEG18
2	External control	External control output	S-Plasma ion	Buzzer	Number of hours using filter
SEG19	SEG20	SEG21	SEG22	SEG23	SEG24
3	Individual control of a remote controller	Heating setting compensation	EEV Step of stopped unit during oil return/defrost mode	Motion detect sensor	--

- ◆ 1WAY/2WAY/4WAY MODEL : Drain pump(SEG8) will be set to 'USE + 3minute delay' even if the drain pump is set to 0.
- ◆ 1 WAY/2WAY/4WAY,DUCT MODEL : Number of hours using filter(SEG18) will be set to '1000hour' even if the SEG18 is set to except for 2 or 6.
- ◆ When setting the option other than above SEG values, the option will be set as "0".
- ◆ SEG5 central control option is basically set as 1 (Use), so you don't need to set the central control option additionally.
However, if the central control is not connected but it doesn't indicate an error message, you need to set the central control option as 0 (Disuse) to exclude the indoor unit from the central control.

Setting an indoor unit address and installation option (Cont.)

■ 02 series installation option(Detailed)

Option No. : 02XXXX-1XXXX-2XXXX-3XXXX

Option	SEG1		SEG2		SEG3		SEG4		SEG5		SEG6			
Explanation	PAGE		MODE		Use of robot cleaning		Use of external room temperature sensor		Use of central control		FAN RPM compensation			
Remote Controller Display														
Indication and Details	Indication	Details	0	2	0	Disuse	0	Disuse	0	Disuse	0	Disuse		
					1	Use	1	Use	1	Use	1	Use	1	RPM compensation
					2	Use	2	Use	2	Use	2	High ceiling KIT		
Option	SEG7		SEG8		SEG9		SEG10		SEG11		SEG12			
Explanation	PAGE		Use of drain pump		Use of hot water heater		Use of electronic heater		EEV Step when heating stops		Master / Slave			
Remote Controller Display														
Indication and Details	Indication	Details	1	2	0	Disuse	0	Disuse	0	Disuse	0	Default value	0	slave
					1	Use	1	Use	1	Use	1	Noise decreasing setting	1	master
					2	When an indoor unit stops, drain pump will operate for 3min	1	Use	1	Use	1	Noise decreasing setting	1	master
Option	SEG13		SEG14		SEG15		SEG16		SEG17		SEG18			
Explanation	PAGE		Use of external control		Setting the output of external control		S-Plasma ion		Buzzer control		Number of hours using filter			
Remote Controller Display														
Indication and Details	Indication	Details	2	2	0	Disuse	0	Thermo on	0	Disuse	0	Use buzzer	2	1000 Hour
					1	ON/OFF control	1	Operation on	1	Use	1	Disuse buzzer	6	2000 Hour
					2	OFF control								
					3	Window ON/OFF control								

Option	SEG19		SEG20		SEG21		SEG22		SEG23		SEG24
Explanation	PAGE		Individual control of a remote controller		Heating setting compensation		EEV Step of stopped unit during oil return/defrost mode		Motion detect sensor		-
Remote Controller Display											
Indication and Details	Indication	Details	0 or 1	channel 1	0	Disuse	0	Default value	0	Disuse	
			1	Turn out in 30min. without motion							
	3		2	channel 2	1	2°C	1	Oil return or Noise decreasing in defrost mode	2	Turn out in 60min. without motion	
			3	channel 3					3	Turn out in 120min. without motion	
			4	channel 4	2	5°C			4	Turn out in 180min. without motion	
			5	Turn out in 30min. without motion or *advanced function					5	Turn out in 30min. without motion or *advanced function	
			6	Turn out in 60min. without motion or *advanced function					6	Turn out in 60min. without motion or *advanced function	
			7	Turn out in 120min. without motion or *advanced function					7	Turn out in 120min. without motion or *advanced function	
			8	Turn out in 180min. without motion or *advanced function					8	Turn out in 180min. without motion or *advanced function	

* Advanced function: Controlling cooling/heating current or power saving with motion detect.

■ 05 series installation option

SEG1	SEG2	SEG3	SEG4	SEG5	SEG6
0	5	Use of Auto Change Over for HR only in Auto mode	(When setting SEG3) Standard heating temp. Offset	(When setting SEG3) Standard cooling temp. Offset	(When setting SEG3) Standard for mode change Heating → Cooling
SEG7	SEG8	SEG9	SEG10	SEG11	SEG12
1	(When setting SEG3) Standard for mode change Cooling → Heating	(When setting SEG3) Time required for mode change	Compensation option for Long pipe or height difference between indoor units	-	-
SEG13	SEG14	SEG15	SEG16	SEG17	SEG18
2	-	-	-	-	-
SEG19	SEG20	SEG21	SEG22	SEG23	SEG24
3	-	-	-	-	-

Setting an indoor unit address and installation option (Cont.)

■ 05 series installation option(Detailed)

Option No. : 05XXXX-1XXXXX-2XXXXX-3XXXXX

Option	SEG1		SEG2		SEG3		SEG4		SEG5		SEG6		
Explanation	PAGE		MODE		Use of Auto Change Over for HR only in Auto mode		(When setting SEG3) Standard heating temp. Offset		(When setting SEG3) Standard cooling temp. Offset		(When setting SEG3) Standard for mode change Heating → Cooling		
Remote Controller Display													
Indication and Details	Indication	Details	0	5	0	Follow product option	0	0	0	0	0	1	
						1							Use Auto Change Over for HR only
					2		1	2	1	2	2		
					3		1.5	3	1.5	3	2.5		
					4		2	4	2	4	3		
					5		2.5	5	2.5	5	3.5		
					6		3	6	3	6	4		
					7	3.5	7	3.5	7	4.5			
Option	SEG7		SEG8		SEG9		SEG10		SEG11		SEG12		
Explanation	PAGE		(When setting SEG3) Standard for mode changing Cooling → Heating mode		(When setting SEG3) Time required for mode change		Compensation option for Long pipe or height difference between indoor units						
Remote Controller Display													
Indication and Details	Indication	Details	1		0	1	0	5 min.	0	Use default value			
						1							
					2	2	2	9 min.	1	1) Height difference ¹⁾ is more than 30m or 2) Distance ²⁾ is longer than 110m			
					3	2.5	3	11 min.					
					4	3	4	13 min.					
					5	3.5	5	15 min.	2	1) Height difference ¹⁾ is 15~30m or 2) Distance ²⁾ is 50~110m			
					6	4	6	20 min.					
					7	4.5	7	30 min.					

¹⁾Height difference : The difference of the height between the corresponding indoor unit and the indoor unit installed at the lowest place.

For example, When the indoor unit is installed 40m higher than the indoor unit installed at the lowest place, select the option "1".

²⁾Distance : The difference between the pipe length of the indoor unit installed at farthest place from an outdoor unit and the pipe length of the corresponding indoor unit from an outdoor unit.

For example, when the farthest pipe length is 100m and the corresponding indoor unit is 40m away from an outdoor unit, select the option "2". (100 - 40 = 60m)

SEG 3, 4, 5, 6, 8, 9 additional information

When the SEG 3 is set as "1" and follow Auto Change Over for HR only operation, it will operate as follows.

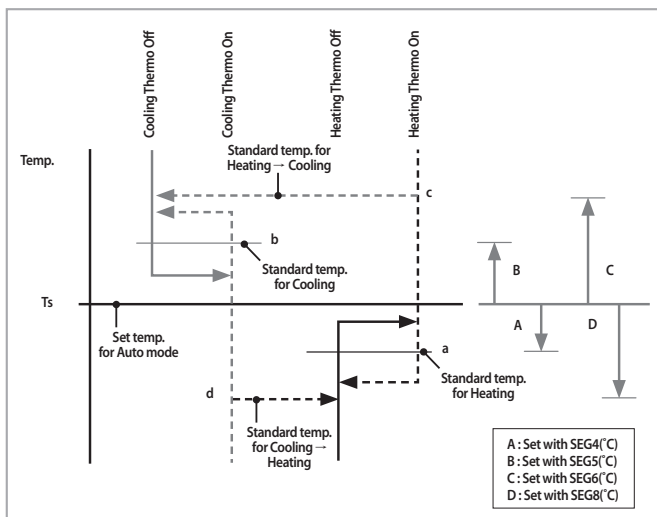

Cooling/Heating mode can be changed when Thermo Off status is maintained during the time with SEG9.

Changing a particular option

You can change each digit of set option.

Option	SEG1	SEG2		SEG3		SEG4		SEG5		SEG6		
Explanation	PAGE	MODE		The option mode you want to change		The tens' digit of an option SEG you will change		The unit digit of an option SEG you will change		Changed value		
Remote Controller Display												
Indication and Details	Indication	Details	Indication	Details	Indication	Details	Indication	Details	Indication	Details	Indication	Details
	0		D		Option mode	1~6	Tens' digit of SEG	0~9	Unit digit of SEG	0~9	The changed value	0~F

Note

- When changing a digit of an indoor unit address setting option, set the SEG3 as 'A'.
- When changing a digit of indoor unit installation option, set the SEG3 as '2'.

Ex) When setting the 'buzzer control' into disuse status.

Option	SEG1	SEG2	SEG3	SEG4	SEG5	SEG6
Explanation	PAGE	MODE	The option mode you want to change	The tens' digit of an option SEG you will change	The unit digit of an option SEG you will change	Changed value
Indication	0	D	2	1	7	1



CAUTION

◆ If you are using heat pump model, mixed operation mode (two or more indoor units operating in different operation mode simultaneously) is not available when the indoor units are connected to same outdoor unit. If you set the master indoor unit with a remote controller, outdoor unit will operate in the mode which was set in the master indoor unit

Все каталоги и инструкции здесь: <http://splitoff.ru/tehn-doc.html>

Final check and trial operation

To complete the installation, perform the following checks and tests to ensure that the air conditioner operates correctly.

Check the following:

- ◆ Strength of the installation site
- ◆ Tightness of pipe connection to detect gas leak
- ◆ Electric wiring connection
- ◆ Heat-resistant insulation of the pipe
- ◆ Drainage
- ◆ Grounding conductor connection
- ◆ Correct operation (follow the steps below)

Providing information for user

After finishing the installation of the air conditioner, you should explain the following to the user. Refer to appropriate pages in the user & installation manual.

- 1 How to start and stop the air conditioner
- 2 How to select the modes and functions
- 3 How to adjust the temperature and fan speed
- 4 How to adjust the airflow direction
- 5 How to set the timers
- 6 How to clean and replace the filters

Note When you complete the installation successfully, hand over the user & installation manual to the user for storage in a handy and safe place.

Troubleshooting

■ Detection of errors

- ◆ If an error occurs during the operation, an LED flickers and the operation is stopped except the LED.
- ◆ If you re-operate the air conditioner, it operates normally at first, then detect an error again.

LED Display on the receiver & display unit





■ LED Display

- ◆ If you turn off the air conditioner when the LED is flickering, the LED is also turned off.
- ◆ If you re-operate the air conditioner, it operates normally at first, then detect an error again.
- ◆ When E108 error occurs, change the address and reset the system.Ex.) When address of the indoor unit #1 and #2 are set as 5, address of the indoor unit #1 will become 5 and indoor unit #2 will display E108. A002

Все каталоги и инструкции здесь: <http://splitoff.ru/tehn-doc.html>

Troubleshooting(Cont.)

● On ○ Flickering ✕ Off

Abnormal condition	Error code	LED Display				
						
Error on indoor temperature sensor (Short or Open)	E121	✕	✕	●	✕	✕
1. Error on Eva-in sensor (Short or Open)	E122	●	✕	●	✕	✕
2. Error on Eva-out sensor (Short or Open)	E123					
3. Discharge sensor error (Short or Open)	E126					
Indoor fan error	E154	✕	✕	✕	●	✕
1. Error on outdoor temperature sensor (Short or Open)	E221					
2. Error on cond sensor	E237	●	✕	✕	●	✕
3. Error on discharge sensor	E251					
Other outdoor unit sensor error that is not on the above list						
1. When there is no communication between the indoor-outdoor units for 2 minutes	E101					
2. Communication error received from the outdoor unit	E102					
3. 3 minute tracking error on outdoor unit	E202					
4. Communication error after tracking due to unmatching number of installed units	E201	✕	✕	●	●	✕
5. Error due to repeated communication address	E108					
6. Communication address not confirmed	E109					
Other outdoor unit communication error that is not on the above list						
Self diagnosis error display						
1. Error due to opened EEV (2nd detection)	E151					
2. Error due to closed EEV (2nd detection)	E152					
3. Eva in sensor is detached	E128	✕	✕	●	●	●
4. Eva out sensor is detached	E129					
5. Thermal fuse error (Open)	E198					
1. COND mid sensor is detached	E241					
2. Refrigerant leakage (2nd detection)	E554					
3. Abnormally high temperature on Cond (2nd detection)	E450					
4. Low pressure s/w (2nd detection)	E451					
5. Abnormally high temperature on discharged air on outdoor unit (2nd detection)	E416					
6. Indoor operation stop due to unconfirmed error on outdoor unit	E559					
7. Error due to reverse phase detection	E425					
8. Comp stop due to freeze detection (6th detection)	E403					
9. High pressure sensor is detached	E301	✕	✕	●	●	●
10. Low pressure sensor is detached	E306					
11. Outdoor unit copression ration error	E428					
12. Outdoor sump down_1 prevetion control	E413					
13. Compressor down due to low pressure sensor prevention control_1	E410					
14. Simultaneous opening of cooling/heating MCU SOL valve (1st detection)	E180					
15. Simultaneous opening of cooling/heating MCU SOL valve (2nd detection)	E181					
Other outdoor unit self-diagnosis error that is not on the above list						
Flowating s/w (2nd detection)	E153	✕	✕	✕	●	●
EEPROM error	E162	●	●	●	●	●
EEPROM option error	E163	●	●	●	●	●
Error due to incompatible indoor unit	E164	✕	✕	✕	✕	●

SAMSUNG



Большая библиотека технической документации
<http://splitoff.ru/tehn-doc.html>
каталоги, инструкции, сервисные мануалы, схемы.